

For Low Pressure

LEVER LOCK CUPLA

Metal Body / Plastic Body

For bulk flow, low pressure applications

Working pressure

0.7 to 1.8

0.7 to 1.8 MPa
(7 to 18 kgf/cm²)

Working pressure

0.2 to 0.5

0.2 to 0.5 MPa
(2 to 5 kgf/cm²)

Valve structure

Straight through

Designs and specifications are subject to change for improvement without notice

Applicable fluids (plastic body CUPLA are for water or air only)

Note: Depending on the temperature of steam / hot water, the heat may damage seal materials.

Light lever pull-down will connect the plug and socket without fail ready to flow liquid or gases.

- This CUPLA complies with diversified applications in liquid or gas transportation.
- End-face seal structure enables no bumps or hollows on the internal fluid passage, and ensures smooth fluid transportation.
- A special lip packing (except sizes 3/4" and 1", silicone rubber, and FEP-covered rubber) employed reduces the load to the lever for easy operation.
- Connection part dimensions comply with US military specifications MIL-A-A-59326.
- The variety of body materials, sizes and end configurations has been standardized to comply with wide range of applications.
- Additional stopper function design will enhance safety (only for made-to-order metal body product).

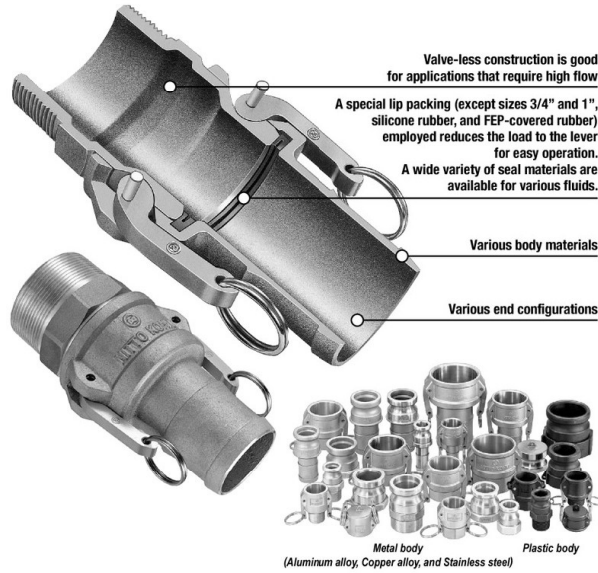

Specifications (Metal Body)

Body material (Material symbol)	Aluminum alloy (AL), Copper alloy (BR)				Stainless steel (SUS)			
Size (Thread and hose)	3/4" to 2"	2 1/2"	3"	4"	3/4" to 2"	2 1/2" to 3"	4"	
Working pressure	MPa	1.8	1.1	0.9	0.7	1.8	1.6	1.1
	kgf/cm ²	18	11	9	7	18	16	11
	bar	18	11	9	7	18	16	11
	PSI	261	160	131	102	261	232	160
Seal material	Nitrile rubber		Silicone rubber		Fluoro rubber			
Working temperature range	-20°C to +80°C		-40°C to +150°C		-20°C to +180°C			
Optional seal material	Seal material	Silicone rubber		Fluoro rubber		Ethylene-propylene rubber		
	Mark	NBR (SG)		FKM (X-100)		EPDM (EPT)		
	Working temperature range	-20°C to +180°C		-40°C to +150°C		-40°C to +150°C		
		-		-		-		
	-		-		-			

*Made-to-order item (Working pressure : 0.2 MPa (2 kgf/cm²))

Specifications (Plastic Body)

Body material (Material symbol)	Polypropylene (PP)							
Size (Thread and hose)	3/4", 1", 1 1/2"			2", 3"				
Working pressure*	MPa	0.5			0.2			
	kgf/cm ²	5			2			
	bar	5			2			
	PSI	72.5			29			
Seal material	Nitrile rubber		Silicone rubber		Fluoro rubber			
Working temperature range	-20°C to +80°C		-40°C to +150°C		-20°C to +180°C			
Optional seal material	Seal material	Silicone rubber		Fluoro rubber		Ethylene-propylene rubber		
	Mark	SI		FKM (X-100)		EPDM (EPT)		
	Working temperature range	-20°C to +180°C		-40°C to +150°C		-40°C to +150°C		
		-		-		-		
	-		-		-			

*Pressure at 20°C. Pressure reduces as temperature rises.

Maximum Tightening Torque Nm (kgf·cm)

Size (Thread)									
Torque	Aluminum alloy	3/4"	1"	1 1/4"	1 1/2"	2"	2 1/2"	3"	4"
	Copper alloy	50 {510}	70 {714}	120 {1224}	140 {1428}	260 {2652}	350 {3570}	410 {4182}	470 {4794}
	Stainless steel	90 {918}	120 {1224}	220 {2244}	260 {2652}	350 {3570}	480 {4896}	520 {5304}	590 {6018}

Flow Direction



Interchangeability

Sockets and plugs can be connected regardless of end configurations if the size is same. Can be connected with products whose mating part dimensions are in compliance with MIL-A-A-59326.

Suitability for Vacuum (Metal Body) 53.0 kPa {400 mmHg}

Socket only	Plug only	When connected
-	-	Operational

Suitability for Vacuum (Plastic Body)

Not suitable for vacuum application in either connected or disconnected condition.

Dimensions with Lever Fully Opened

Metal	Size	Dimensions E (mm)			Plastic	Size	Dimensions E (mm)
		Body material					
	3/4"	AL (122.5)	BR (122.5)	SUS (111)		3/4"	(115)
	1"	(132)	(132)	(125)		1"	(126)
	1 1/4"	(183)	(183)	(179)		1 1/2"	(187)
	1 1/2"	(191)	(191)	(187)		2"	(195)
	2"	(201)	(201)	(196)		3"	(249)
	2 1/2"	(213)	(209)	(209)			
	3"	(249)	(249)	(251)			
	4"	(280)	(278)	(277)			

LEVER LOCK CUPLA (Metal)

Models and Dimensions

Dimensions of products may differ according to body material. / WAF : WAF stands for width across flats.

Plug LE type (Hose barb)

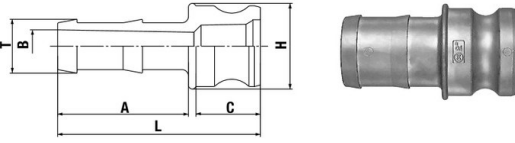

Material	Model	Application (Hose)	Mass (g)	Dimensions (mm)					
				L	A	C	øH	øT	øB
Aluminum alloy	LE-6TPH	3/4"	65	81	52	26	34	21.4	11
	LE-8TPH	1"	100	95	58	34	40	27.4	17.5
	LE-10TPH	1 1/4"	140	102	58	40	48	34.1	23.5
	LE-12TPH	1 1/2"	190	107	61	42	58	40.5	29
	LE-16TPH	2"	290	122	70	48	69	53.2	40
	LE-20TPH	2 1/2"	390	134.5	80	50	81	66.7	50
Copper alloy	LE-6TPH	3/4"	215	90.5	52.5	26	39	21.5	12.5
	LE-8TPH	1"	305	107	60	34.5	41	27.5	20
	LE-10TPH	1 1/4"	440	102	58	40	48	34.1	25.5
	LE-12TPH	1 1/2"	560	107	61	42	58	40.5	31.5
	LE-16TPH	2"	865	131	73	44	70.5	53.5	44.5
	LE-20TPH	2 1/2"	1180	149	84	48	91	67	57
Stainless steel	LE-6TPH	3/4"	170	90	52	27	35	21	15
	LE-8TPH	1"	265	107	60	35	42	27	20
	LE-10TPH	1 1/4"	430	111	61	40	48	34	25.5
	LE-12TPH	1 1/2"	530	114	61	40	60	40	33
	LE-16TPH	2"	790	131	73	45	70	53	44
	LE-20TPH	2 1/2"	1195	137	80.5	42.7	83	67	56

Socket LC type (Hose barb)

Model LC-6TSH made of aluminum alloy and copper alloy has no rings.

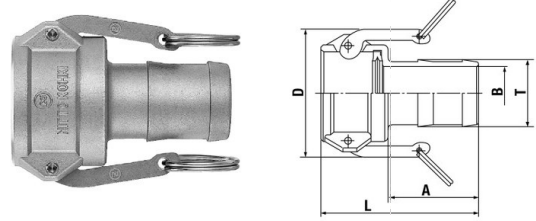

Material	Model	Application (Hose)	Mass (g)	Dimensions (mm)					
				L	A	D	øT	øB	
Aluminum alloy	LC-6TSH	3/4"	140	85	52	(60.5)	21.4	(11)	
	LC-8TSH	1"	190	99	58	(61)	27.4	(17)	
	LC-10TSH	1 1/4"	320	104	58	(82)	34.1	(23)	
	LC-12TSH	1 1/2"	350	108.5	61	(90)	40.5	(29)	
	LC-16TSH	2"	430	122.5	70	(100)	53.2	(41.5)	
	LC-20TSH	2 1/2"	560	136.5	80	(112)	66.7	(54)	
Copper alloy	LC-6TSH	3/4"	320	85	52	(60.5)	21.4	13	
	LC-8TSH	1"	420	99	58	(61)	27.4	19.5	
	LC-10TSH	1 1/4"	700	104	58	(82)	34.1	25.5	
	LC-12TSH	1 1/2"	720	110	62	(91)	41	33	
	LC-16TSH	2"	870	121	70	(100)	53	44	
	LC-20TSH	2 1/2"	1530	137	83	(113)	67	57	
Stainless steel	LC-6TSH	3/4"	230	86	52	(55)	21	15	
	LC-8TSH	1"	340	99	60	(63)	27	20	
	LC-10TSH	1 1/4"	615	107	61	(85)	34	25.5	
	LC-12TSH	1 1/2"	645	108	61	(91)	40	33	
	LC-16TSH	2"	1000	129	73	(101)	53	44	
	LC-20TSH	2 1/2"	1270	134	81	(113)	67	57	

Plug LA type (Female thread)

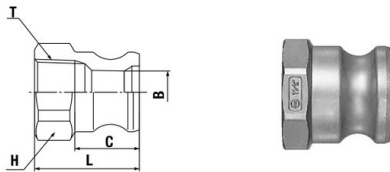

Material	Model	Application (Thread)	Mass (g)	Dimensions (mm)					
				L	C	H(WAF)	øB	T	
Aluminum alloy	LA-6TPF	3/4"	45	42	26	Hex.36	17	Rc 3/4	
	LA-8TPF	1"	65	52	34	Hex.41	22.5	Rc 1	
	LA-10TPF	1 1/4"	110	59	40	Hex.50	27.5	Rc 1 1/4	
	LA-12TPF	1 1/2"	130	58	42	Hex.60	34.5	Rc 1 1/2	
	LA-16TPF	2"	170	63.5	48	Oct.70	44.5	Rc 2	
	LA-20TPF	2 1/2"	320	85	50	Oct.85	55.5	Rc 2 1/2	
Copper alloy	LA-6TPF	3/4"	145	42	27	Oct.34	20	Rc 3/4	
	LA-8TPF	1"	190	46	32	Oct.41	24	Rc 1	
	LA-10TPF	1 1/4"	390	59	40	Hex.50	28	Rc 1 1/4	
	LA-12TPF	1 1/2"	420	58	42	Oct.60	36	Rc 1 1/2	
	LA-16TPF	2"	560	63.5	48	Oct.70	45	Rc 2	
	LA-20TPF	2 1/2"	950	79	50	Dod.84	56	Rc 2 1/2	
Stainless steel	LA-6TPF	3/4"	120	39	27	Oct.33	19	Rc 3/4	
	LA-8TPF	1"	170	47	33	Oct.41	24	Rc 1	
	LA-10TPF	1 1/4"	270	53.5	41	Oct.50	28	Rc 1 1/4	
	LA-12TPF	1 1/2"	375	55	40	Oct.58	35.5	Rc 1 1/2	
	LA-16TPF	2"	505	62	47	Oct.69	45	Rc 2	
	LA-20TPF	2 1/2"	825	77	49	Dod.83	56	Rc 2 1/2	

Socket LD type (Female thread)

Model LD-6TSF made of aluminum alloy and copper alloy has no rings.

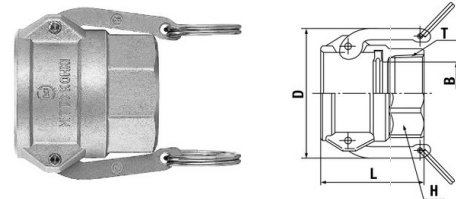

Material	Model	Application (Thread)	Mass (g)	Dimensions (mm)					
				L	D	H(WAF)	øB	T	
Aluminum alloy	LD-6TSF	3/4"	130	53	(62.4)	Hex.36	21	Rc 3/4	
	LD-8TSF	1"	190	64.5	(61)	Hex.41	26	Rc 1	
	LD-10TSF	1 1/4"	330	72.5	(82)	Hex.50	34	Rc 1 1/4	
	LD-12TSF	1 1/2"	360	70.5	(90)	Oct.60	39	Rc 1 1/2	
	LD-16TSF	2"	420	79.5	(100)	Oct.70	49	Rc 2	
	LD-20TSF	2 1/2"	550	88.5	(112)	Oct.85	59	Rc 2 1/2	
Copper alloy	LD-6TSF	3/4"	310	53	(60.5)	Hex.36	21	Rc 3/4	
	LD-8TSF	1"	430	64.5	(61)	Hex.41	26	Rc 1	
	LD-10TSF	1 1/4"	730	72.5	(82)	Hex.50	34	Rc 1 1/4	
	LD-12TSF	1 1/2"	770	70.5	(90)	Oct.60	39	Rc 1 1/2	
	LD-16TSF	2"	990	79.5	(100)	Oct.70	49	Rc 2	
	LD-20TSF	2 1/2"	1290	81.5	(113)	Dod.84	61	Rc 2 1/2	
Stainless steel	LD-6TSF	3/4"	225	52	(55)	Oct.32	19	Rc 3/4	
	LD-8TSF	1"	350	60	(63)	Oct.41	24	Rc 1	
	LD-10TSF	1 1/4"	600	68	(85)	Oct.50	30	Rc 1 1/4	
	LD-12TSF	1 1/2"	715	72	(87)	Oct.58	37.5	Rc 1 1/2	
	LD-16TSF	2"	940	78.5	(100)	Oct.69	50	Rc 2	
	LD-20TSF	2 1/2"	1050	82	(113)	Dod.83	61	Rc 2 1/2	

Before use, please be sure to read "Safety Guide" described at the end of this book and "Instruction Sheet" that comes with the products.

LEVER LOCK CUPLA (Metal)

Dimensions of products may differ according to body material. / WAF : WAF stands for width across flats.

Models and Dimensions

Plug LF type (Male thread)

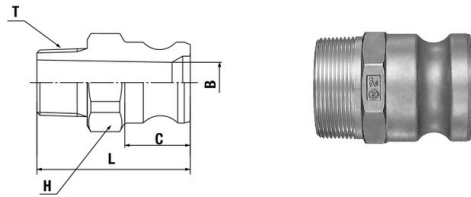

Material	Model	Application (Thread)	Mass (g)	Dimensions (mm)			Oct. stands for octagon. Dod.stands for dodecagon.	
				L	C	H(WAF)	øB	T
Aluminum alloy	LF-6TPM	3/4"	70	61	26	Hex.36	16	R 3/4
	LF-8TPM	1"	90	73	34	Hex.41	22	R 1
	LF-10TPM	1 1/4"	140	81	40	Hex.50	28	R 1 1/4
	LF-12TPM	1 1/2"	150	80.5	42	Oct.55	34.5	R 1 1/2
	LF-16TPM	2"	220	89.5	48	Oct.65	44.5	R 2
	LF-20TPM	2 1/2"	370	101	50	Oct.80	56	R 2 1/2
	LF-24TPM	3"	470	106	52	Dod.99	73	R 3
LF-32TPM	4"	875	116	54	Dod.130	100	R 4	
Copper alloy	LF-6TPM	3/4"	185	59	27	Oct.34	20	R 3/4
	LF-8TPM	1"	280	69	32	Oct.41	24	R 1
	LF-10TPM	1 1/4"	460	81	40	Hex.50	28	R 1 1/4
	LF-12TPM	1 1/2"	500	80.5	42	Oct.55	36	R 1 1/2
	LF-16TPM	2"	750	89.5	48	Oct.65	45	R 2
	LF-20TPM	2 1/2"	1290	98	50	Dod.83	56	R 2 1/2
	LF-24TPM	3"	1480	103	50.8	Dod.96	73	R 3
LF-32TPM	4"	3155	113	53	Dod.126	100	R 4	
Stainless steel	LF-6TPM	3/4"	175	59	27	Oct.33	19	R 3/4
	LF-8TPM	1"	255	69	33	Oct.41	24	R 1
	LF-10TPM	1 1/4"	415	80	42	Oct.50	29.5	R 1 1/4
	LF-12TPM	1 1/2"	575	80	40	Oct.58	36.5	R 1 1/2
	LF-16TPM	2"	680	90	46.5	Oct.69	46	R 2
	LF-20TPM	2 1/2"	1020	99	49	Dod.83	56	R 2 1/2
	LF-24TPM	3"	1415	103	51	Dod.96	73	R 3
LF-32TPM	4"	2275	112	53	Dod.124	100	R 4	

Socket LB type (Male thread)

Model LB-6TSM made of aluminum alloy has no rings.

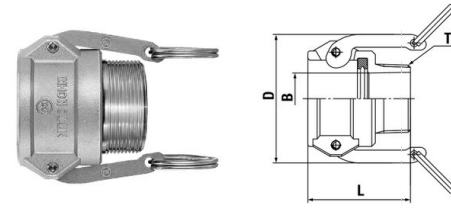

Material	Model	Application (Thread)	Mass (g)	Dimensions (mm)			
				L	D	øB	T
Aluminum alloy	LB-6TSM	3/4"	110	53	(60.5)	(17)	R 3/4
	LB-8TSM	1"	170	65	(61)	(235)	R 1
	LB-10TSM	1 1/4"	310	72	(82)	29.5	R 1 1/4
	LB-12TSM	1 1/2"	340	71.5	(90)	36	R 1 1/2
	LB-16TSM	2"	400	79.5	(100)	(46)	R 2
	LB-20TSM	2 1/2"	530	88.5	(112)	(57.5)	R 2 1/2
	LB-24TSM	3"	715	90	(139)	76	R 3
LB-32TSM	4"	920	92	(165)	99	R 4	
Copper alloy (made-to-order item)	LB-6TSM	3/4"	260	52	(53)	19.5	R 3/4
	LB-8TSM	1"	355	63	(62)	26	R 1
	LB-10TSM	1 1/4"	620	71	(84)	28	R 1 1/4
	LB-12TSM	1 1/2"	700	71	(91)	36	R 1 1/2
	LB-16TSM	2"	950	81	(100)	51	R 2
	LB-20TSM	2 1/2"	1250	86	(113)	63	R 2 1/2
	LB-24TSM	3"	1780	92	(139)	78	R 3
LB-32TSM	4"	2540	98	(168)	101	R 4	
Stainless steel (available on request)	LB-6TSM	3/4"	210	52.5	(55)	20	R 3/4
	LB-8TSM	1"	300	63	(63)	25.5	R 1
	LB-10TSM	1 1/4"	520	70.5	(85)	34	R 1 1/4
	LB-12TSM	1 1/2"	580	71.5	(87)	38	R 1 1/2
	LB-16TSM	2"	780	78.5	(101)	50.5	R 2
	LB-20TSM	2 1/2"	980	84	(113)	66	R 2 1/2
	LB-24TSM	3"	1490	92	(139)	78.5	R 3
LB-32TSM	4"	2080	92	(167)	103.5	R 4	

Plug L-PD type (Plug cap)

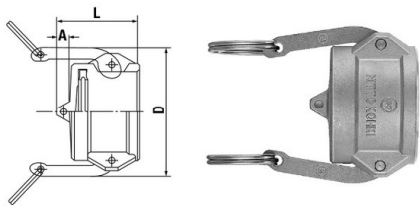

Material	Model	Size	Mass (g)	Dimensions (mm)		
				L	A	D
Aluminum alloy	L-6PD	3/4"	100	46	12	(54)
	L-8PD	1"	145	54	11.5	(62)
	L-10PD	1 1/4"	230	60	13	(83)
	L-12PD	1 1/2"	295	68	17	(91)
	L-16PD	2"	360	68	11	(100)
	L-20PD	2 1/2"	435	72	15	(113)
	L-24PD	3"	690	72	10	(139)
LF-32PD	4"	870	76	15	(167)	
Copper alloy	L-6PD	3/4"	220	45	11	(53)
	L-8PD	1"	315	53	12	(62)
	L-10PD	1 1/4"	610	61	13	(84)
	L-12PD	1 1/2"	645	69	17.5	(91)
	L-16PD	2"	830	68	11	(100)
	L-20PD	2 1/2"	980	71	14	(113)
	L-24PD	3"	1380	81	20	(139)
L-32PD	4"	2700	90	26	(168)	
Stainless steel	L-6PD	3/4"	180	45	12	(55)
	L-8PD	1"	265	52	11	(63)
	L-10PD	1 1/4"	475	60	11	(85)
	L-12PD	1 1/2"	545	63	15	(87)
	L-16PD	2"	720	65	11	(101)
	L-20PD	2 1/2"	945	71	15	(113)
	L-24PD	3"	1420	72	12	(139)
L-32PD	4"	2055	77	14	(167)	

Socket L-SD type (Socket cap)

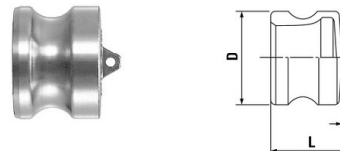

Material	Model	Size	Mass (g)	Dimensions (mm)		
				L	A	øD
Aluminum alloy	L-6SD	3/4"	35	32	8	32
	L-8SD	1"	45	44	10	36.7
	L-10SD	1 1/4"	70	57	14	45.5
	L-12SD	1 1/2"	90	54	15	53.4
	L-16SD	2"	140	62	13	63
	L-20SD	2 1/2"	210	69	20	75.8
	L-24SD	3"	290	71	15	91.5
LF-32SD	4"	960	74	16	119.4	
Copper alloy	L-6SD	3/4"	160	34	8	32.1
	L-8SD	1"	150	44	10	36.7
	L-10SD	1 1/4"	210	55	12	45.5
	L-12SD	1 1/2"	290	54	15	53.4
	L-16SD	2"	420	61	12	63
	L-20SD	2 1/2"	630	69	19	75.7
	L-24SD	3"	860	71	15	91.5
L-32SD	4"	1780	74.5	16	119.4	
Stainless steel	L-6SD	3/4"	95	39	12	32
	L-8SD	1"	145	45	12	37
	L-10SD	1 1/4"	250	51	10	45
	L-12SD	1 1/2"	300	54	14	53
	L-16SD	2"	490	59.5	12.5	63
	L-20SD	2 1/2"	710	64	14	76
	L-24SD	3"	930	68	14	92
L-32SD	4"	1275	68	14	120	

LEVER LOCK CUPLA (Plastic)

Models and Dimensions Designs and specifications are subject to change for improvement without notice. / WAF : WAF stands for width across flats.

Plug LE type (Hose barb)

Material	Model	Application (Hose)	Mass (g)	Dimensions (mm)					
				L	A	C	øH	øT	øB
Plastic	LE-6TPH	3/4"	16	74.5	51.5	(23)	(32)	20.7	14.2
	LE-8TPH	1"	29	87.5	57.5	(30)	(36.5)	26.3	19
	LE-12TPH	1 1/2"	73	103	61.5	(41.5)	(53.5)	40	30
	LE-16TPH	2"	122	119	71	(48)	(63)	52.5	41
	LE-24TPH	3"	221	151.5	106.5	(45)	(91.5)	77	64.5

Socket LC type (Hose barb)

Material	Model	Application (Hose)	Mass (g)	Dimensions (mm)				
				L	A	H	øT	øB
Plastic	LC-6TSH	3/4"	64	83	52	(63.5)	20.2	14
	LC-8TSH	1"	104	97.5	56.5	(73)	26.2	20
	LC-12TSH	1 1/2"	242	109.5	58	(95)	39	29.5
	LC-16TSH	2"	269	125	70.5	(105.5)	52.5	41
	LC-24TSH	3"	527	161	102	(136.5)	77	64.5

Plug LA type (Female thread)

Material	Model	Application (Thread)	Mass (g)	Dimensions (mm)				
				L	C	H(WAF)	øB	T
Plastic	LA-6TPF	3/4"	19	42	(26)	Hex.43	21.3	Rc 3/4
	LA-8TPF	1"	27	59	(34)	Hex.43	22	Rc 1
	LA-12TPF	1 1/2"	65	67	(42)	Ribbed 65	34	Rc 1 1/2
	LA-16TPF	2"	102	73	(47.5)	Ribbed 78	42	Rc 2
	LA-24TPF	3"	211	90	(52.5)	Ribbed 108	71	Rc 3

Socket LD type (Female thread)

Material	Model	Application (Thread)	Mass (g)	Dimensions (mm)			
				L	H(WAF)	øB	T
Plastic	LD-6TSF	3/4"	65	49	Hex.32	21.5	Rc 3/4
	LD-8TSF	1"	98	61	Hex.41	27	Rc 1
	LD-12TSF	1 1/2"	260	77.5	Ribbed 68	39	Rc 1 1/2
	LD-16TSF	2"	285	83	Ribbed 80	51	Rc 2
	LD-24TSF	3"	444	90.5	Ribbed 109	77.5	Rc 3

Plug LF type (Male thread)

Material	Model	Application (Thread)	Mass (g)	Dimensions (mm)				
				L	C	H(WAF)	øB	T
Plastic	LF-6TPM	3/4"	23	60	(26)	Hex.32	19	R 3/4
	LF-8TPM	1"	19	71	(34)	Hex.37	23	R 1
	LF-12TPM	1 1/2"	72	77	(42)	Ribbed 63	32	R 1 1/2
	LF-16TPM	2"	105	84.5	(48)	Ribbed 74	44.5	R 2
	LF-24TPM	3"	210	102.5	(51.5)	Ribbed 100	72	R 3

Socket LB type (Male thread)

Material	Model	Application (Thread)	Mass (g)	Dimensions (mm)			
				L	H	øB	T
Plastic	LB-6TSM	3/4"	58	49.5	(63.5)	19	R 3/4
	LB-8TSM	1"	88	61	(73)	23.5	R 1
	LB-12TSM	1 1/2"	227	77.5	(95)	37	R 1 1/2
	LB-16TSM	2"	251	82.5	(105.5)	48	R 2
	LB-24TSM	3"	397	88	(136.5)	75	R 3

Plug L-PD type (Plug cap)

Material	Model	Size	Mass (g)	Dimensions (mm)		
				L	A	H
Plastic	L-6PD	3/4"	60	45	12	(63.5)
	L-8PD	1"	94	55.5	12	(73)
	L-12PD	1 1/2"	214	65	15	(95)
	L-16PD	2"	219	70.5	16	(106)
	L-24PD	3"	408	77	17.5	(136)

Socket L-SD type (Socket cap)

Material	Model	Size	Mass (g)	Dimensions (mm)		
				L	A	øD
Plastic	L-6SD	3/4"	10	35.5	12	(32.1)
	L-8SD	1"	18	42.5	11	(36.5)
	L-12SD	1 1/2"	46	53.5	14	(53.2)
	L-16SD	2"	68	63	16	(63)
	L-24SD	3"	102	71	17.5	(109)

Before use, please be sure to read "Safety Guide" described at the end of this book and "Instruction Sheet" that comes with the products.